

en Installation instructions
fr Notice de montage
de Montageanweisung
es Instrucciones de montaje
it Istruzioni di montaggio
sv Installation och skötself
cn 安装说明书
ru Инструкция по монтажу
ar إرشادات التثبيت

Thermal overload relay B45N
Relais de protection thermique B45N
Thermisches Überlastrelais B45N
Relé térmico de sobrecarga B45N
Relè termico B45N
Termiskt överlastrelä B45N
热过载继电器B45N
Тепловое реле защиты от перегрузки B45N
مرحل حراري يعمل عند تجاوز الحمل B45N

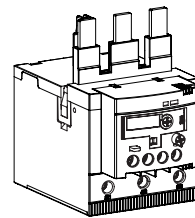

Doc.No. 4TQE579906F0001 (a)



<p>ar تحذير: جهد كهربائي خطراً راجع تعليمات التشغيل. افصل الكهرباء وقم بتأمينها قبل العمل في هذا الجهاز تتبه! يجب عدم التركيب إلا من خلال شخص على دراية بمجال التقنية الكهربائية .</p> <p>bg Предупреждение: Опасно напрежение! Вижте инструкциите за работа. Изключете и блокирайте захранването преди да работите с устройството. Внимание! Да се монтира само от експерт електротехник.</p> <p>cs Varování: Nebezpečné napětí! Viz návod k obsluze. Před zahájením prací na tomto zařízení odpojte a uzamkněte napájení. Pozor! Toto zařízení smí instalovat pouze osoba s elektrotechnickou odborností.</p> <p>da Advarsel: Farlig elektrisk spænding! Se betjeningsvejledningen. Frakobl enheden, og afbryd strømforsyningen, før du arbejder med denne enhed. Giv agt! Installation må kun foretages af personer med elektroteknisk ekspertise.</p> <p>de Warnung: Gefährliche Spannung! Siehe Bedienungsanleitung. Vor dem Arbeiten Gerät ausschalten und von der Spannungsversorgung trennen. Achtung! Installation nur durch elektrotechnische Fachkraft.</p> <p>el Προειδοποίηση: Επικίνδυνη τάση! Ανατρέξτε στις οδηγίες λειτουργίας. Αποσυνδέστε και απομονώστε την παροχή ισχύος προτού ξεκινησετε τις εργασίες σε αυτήν τη συσκευή. Προσοχή! Η εγκατάσταση πρέπει να γίνεται μόνο από αδειούχο ηλεκτρολόγο εγκαταστάτη.</p> <p>en Warning: Hazardous voltage! Refer to operating instructions. Disconnect and lock out power before working on this device. Attention! Installation by person with electrotechnical expertise only.</p> <p>es Advertencia: ¡Tensión peligrosa! Consulte las instrucciones de funcionamiento. Antes de trabajar con este dispositivo, desconecte y bloquee la corriente. ¡Atención! La instalación debe ser realizada únicamente por un técnico electricista.</p> <p>et Hoiatus: Elektrilöögi oht! Lisateavet vaadake kasutusjuhendist. Enne selle seadmega töötamist ühendage lahti ja lukustage toide. Tähelepanu! Seadet tohib paigaldada ainult elektrotehnilise kogemusega isik.</p> <p>fi Varoitusta: Vaarallinen jännite! Katso käyttöohje. Katkaise virta ja estä virran kytkeminen lukituksella ennen töiden aloittamista. Huomio! Asennuksen saa suorittaa vain henkilö, jolla on kokemusta sähkötekniikasta.</p> <p>fr Avertissement: Tension dangereuse! Consultez les consignes d'utilisation. Débranchez et verrouillez l'alimentation électrique avant d'entreprendre des travaux sur cet appareil. Attention! L'installation doit être effectuée uniquement par une personne ayant une expertise en électrotechnique.</p> <p>hr Upozorenje: Opasan napon! Pogledajte upute za uporabu. Odspojite i isključite struju prije rada na ovom uređaju. Pažnja! Ugradnja je dopuštena samo osobama stručnim u području elektrotehnike.</p> <p>hu Figyelmeztetés: Veszélyes feszültség! Lásd a használati utasítást. Vállassza le és zárja ki az áramellátást, mielőtt a berendezésen dolgozni kezd. Figyelem! Az üzembé helyezésést csak elektrotechnikai szakértelemmel rendelkező személy végezheti el.</p> <p>it Attenzione: Tensione pericolosa! Fare riferimento alle istruzioni per l'uso. Prima di intervenire su questo dispositivo, scollegare e isolare tutte le fonti di alimentazione. Attenzione! L'installazione deve essere eseguita esclusivamente da un installatore qualificato.</p>	<p>it Ispejimas: Pavojinga įtampa! Žr. naudojimo instrukcijas. Atjunkite ir laikinai užblokuokite maitinimą prieš dirbdami su šiuo įrenginiu. Dėmesio! Įrengti gali tik asmuo, turintis elektrotechniko patirties.</p> <p>lv Brīdinājums: Bīstams spriegums! Skatiet darba norādījumus. Pirms sākat darbu ar šo ierīci, atvienojiet un bloķējiet strāvas padevi. Uzmanību! Uzstādīšanu drīkst veikt tikai persona ar zināšanām par elektrotehniku.</p> <p>nl Waarschuwing: Gevaarlijke spanning! Raadpleeg de bedieningsinstructies. Koppel dit apparaat los van de stroomvoorziening voordat u werkzaamheden uitvoert. Let op! Installatie mag alleen worden uitgevoerd door een monteur met elektrotechnische expertise.</p> <p>no Advarsel: Farlig spenning! Se i bruksanvisningen. Koble fra og steng av strømmen før du arbeider på denne enheten. Forsiktig! Montering skal kun utføres av kvalifiserte personer med elektrokompetanse.</p> <p>pl Ostrzeżenie: Niebezpieczne napięcie! Patrz: instrukcja obsługi. Przed rozpoczęciem wykonywania pracy z tym urządzeniem odłącz i zablokuj zasilanie. Uwaga! Montaż może wykonywać wyłącznie osoba posiadająca doświadczenie elektrotechniczne.</p> <p>pt Aviso: Tensão perigosa! Consulte as instruções de operação. Desconecte e desligue a energia elétrica antes de trabalhar nesse dispositivo. Atenção! A instalação deve ser feita apenas por uma pessoa com especialidade eletrotécnica.</p> <p>ro Avertisment: Tensiune electrică periculoasă! Consultați instrucțiunile de utilizare. Deconectați și închideți sursa de energie înainte de a lucra cu acest dispozitiv. Atenție! Instalarea trebuie realizată doar de către o persoană cu expertiză electrotehnică.</p> <p>ru Внимание: Опасное электрическое напряжение! Обратитесь к инструкциям по эксплуатации. Отключите питание и обесточьте устройство перед началом работ. Внимание! Установка должна выполняться только специалистом по электротехническим работам.</p> <p>sk Výstraha: Nebezpečné napätie! Pozrite si návod na použitie. Pred začatím prác na tomto zariadení odpojte a zablokujte napájanie. Pozor! Inštaláciu smie vykonávať len osoba s odbornými znalosťami v oblasti elektrotechniky.</p> <p>sl Opozorilo: Nevarna napetost! Glejte navodila za uporabo. Pred delom na tej napravi izklopite in zaklenite električno napajanje. Pozor! Namestitve sme izvesti samo elektrotehnični strokovnjak.</p> <p>sv Varning: Livsfarlig spänning! Se i bruksanvisningen. Frånkoppla och blockera anläggning eller en anläggningsdel innan arbete utförs. Obs! Far endast installeras av behörig elektriker.</p> <p>tr Uyarı: Tehlikeli gerilim! Çalışma talimatlarını bakın. Bu cihaz üzerinde çalışmadan önce elektrikli kesim ve kilitleyin. Dikkat! Yalnızca elektroteknik uzmanlığı sahip kişiler tarafından kurulabilir.</p> <p>zh 警告：高压危险！ 请参见操作手册 操作本设备前请断开并锁定电源。 注意！安装仅限专业电工人员。</p>
--	--

en Thermal overload relay with phase loss sensitivity according to IEC/EN 60947-4-1.
Ambient air temperature -25 ... +60 °C.

fr Relais de surcharge thermique sensible à la perte de phase conformément à la norme IEC/EN 60947-4-1.
Température ambiante -25 ... +60 °C.

de Thermisches Überlastrelais mit Phasenausfallempfindlichkeit nach IEC/EN 60947-4-1.
Umgebungstemperatur -25 ... +60 °C.

es Relé térmico de sobrecarga con sensibilidad de protección de fase según IEC/EN 60947-4-1.
Temperatura ambiente: -25 ... +60 °C.

it Relé di sovraccarico termico con rilevamento della perdita di fase secondo la norma IEC/EN 60947-4-1.
Temperatura ambiente -25 ... +60 °C.

sv Termiskt överbelastningsskydd med känslighet för fasbortfall i enlighet med IEC/EN 60947-4-1.
Omgivningstemperatur -25 ... +60 °C.

cn 根据IEC/EN 60947-4-1标准。
带缺相保护的热过载继电器温度范围
-25 ... +60 °C。

ru Тепловое реле защиты от перегрузки с чувствительностью против обрыва фазы соответственно IEC/EN 60947-4-1.
Температура окружающей среды -25 ... +60 °C.

ar التتابع الزائد الحراري مع مرحل الحمل الزائد الحراري مع حساسية فشل الطور وفقاً للمعيار IEC / EN 60947-4-1
درجة الحرارة المحيطة -25 ... +60 °C

LS45N – B45N

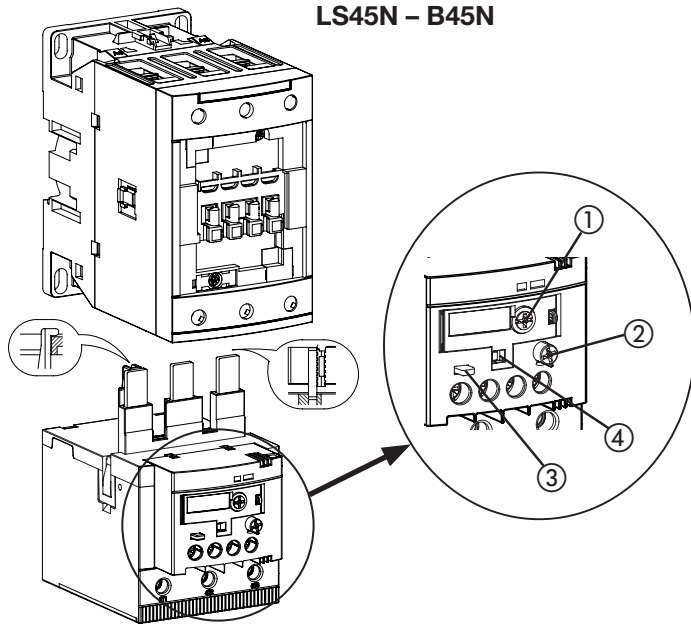

① I_{nom}
en Setting the relay to rated current of the motor

② RESET

-M

-A

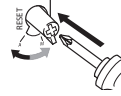

en In case of adjusting "RESET A", which means automatic reset after tripping, the motor may restart automatically. This automatic restart could injure persons and damage material.

③ STOP

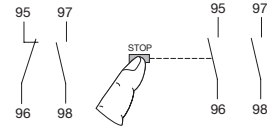

④ TEST

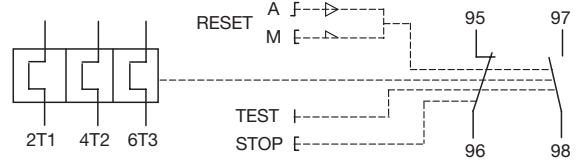
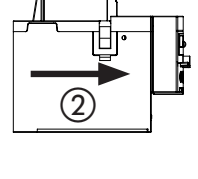
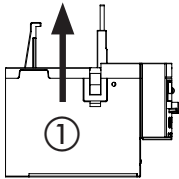
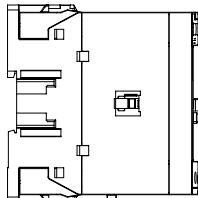
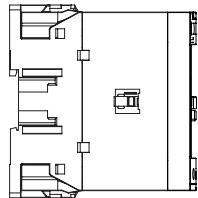
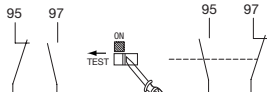

VST45N + B45N

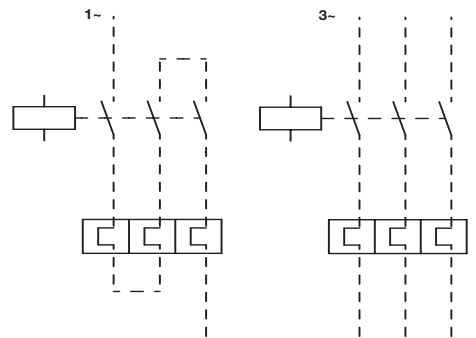
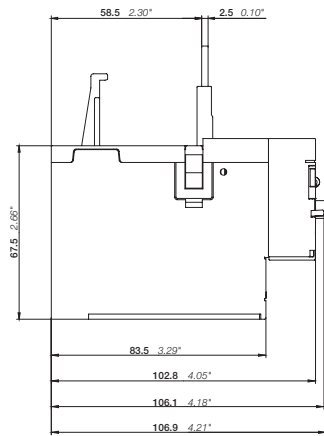
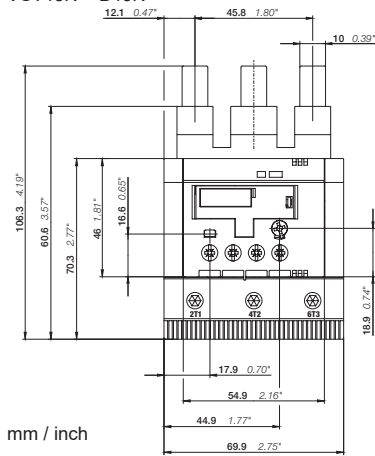

B45N								
2T1 4T2 6T3	M8 6 ... 9.0 Nm 53 ... 80 lb.in	∅ 6.5 mm	Hexagon 4	1 x 6 ... 50 mm ² 1/2 x 6 ... 35 mm ² 1 x AWG 8 ... 1 2 x AWG 8 ... 3	1 x 6 ... 50 mm ² 1/2 x 6 ... 35 mm ² 1 x AWG 8 ... 1 2 x AWG 8 ... 3	1 x 6 ... 50 mm ² 1/2 x 6 ... 35 mm ²	1 x 6 ... 50 mm ² 1/2 x 6 ... 16 mm ²	20 mm
95 - 96 97 - 98	M3 1.0 ... 1.2 Nm 9 ... 11 lb.in	∅ 5.5 mm	Pozidriv No. 2	1/2 x 0.75 ... 4 mm ² 1/2 x AWG 18 ... 12	1/2 x 0.75 ... 1.0 mm ² 1/2 x 1.0 ... 2.5 mm ² 1/2 x AWG 18 ... 12	1/2 x 0.75 ... 2.5 mm ²	1 x 0.75 ... 2.5 mm ² 2 x 0.75 ... 1.5 mm ²	9 mm