

Sistema ModularDIN™

Istruzioni di montaggio
Instructions for use

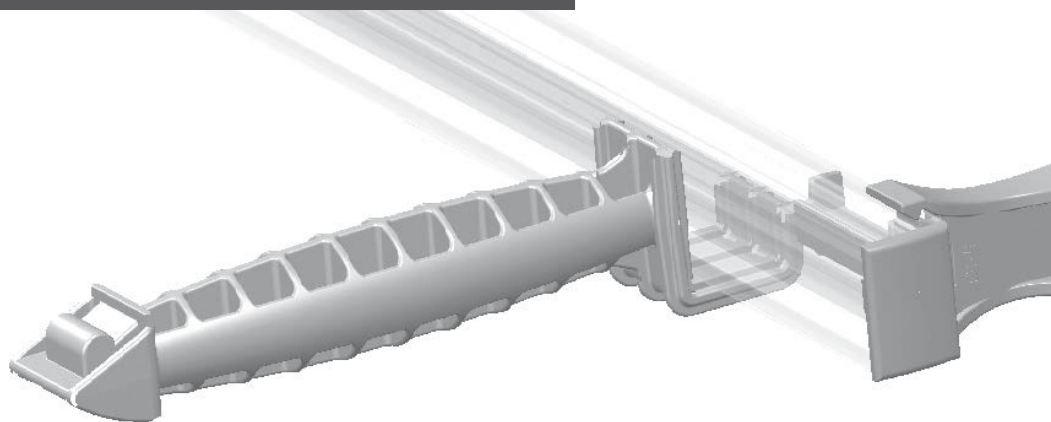

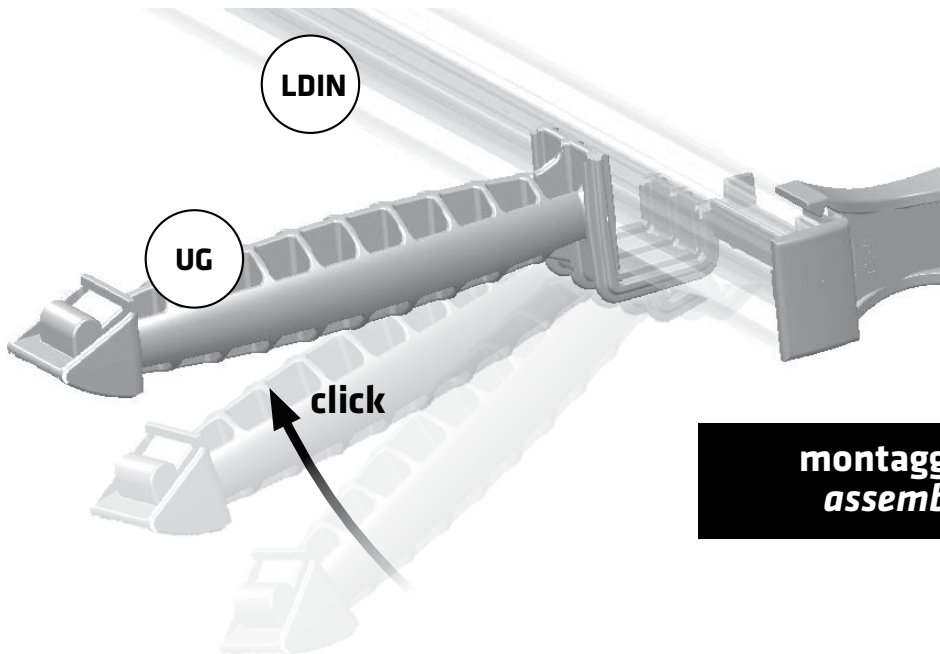

montaggio
assembly

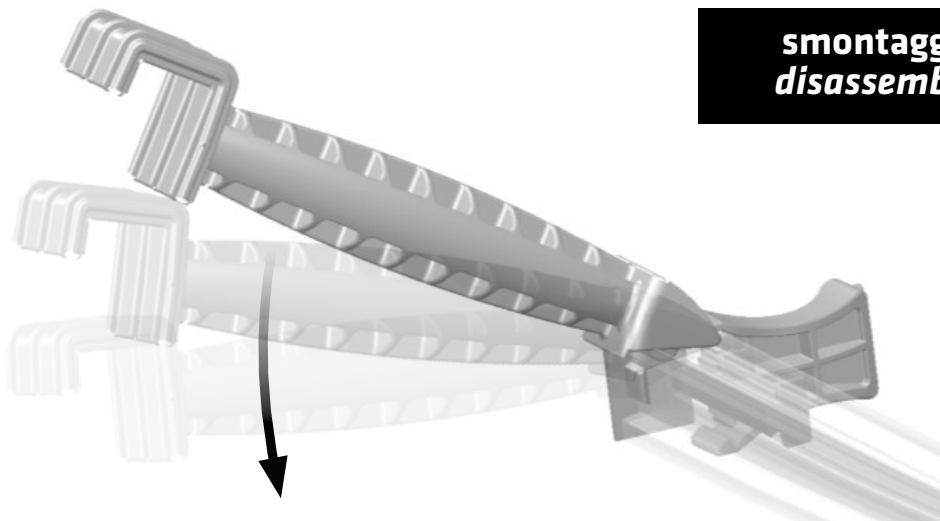

smontaggio
disassembly

montaggio supporto canale orizzontale
horizontal chute support assembly

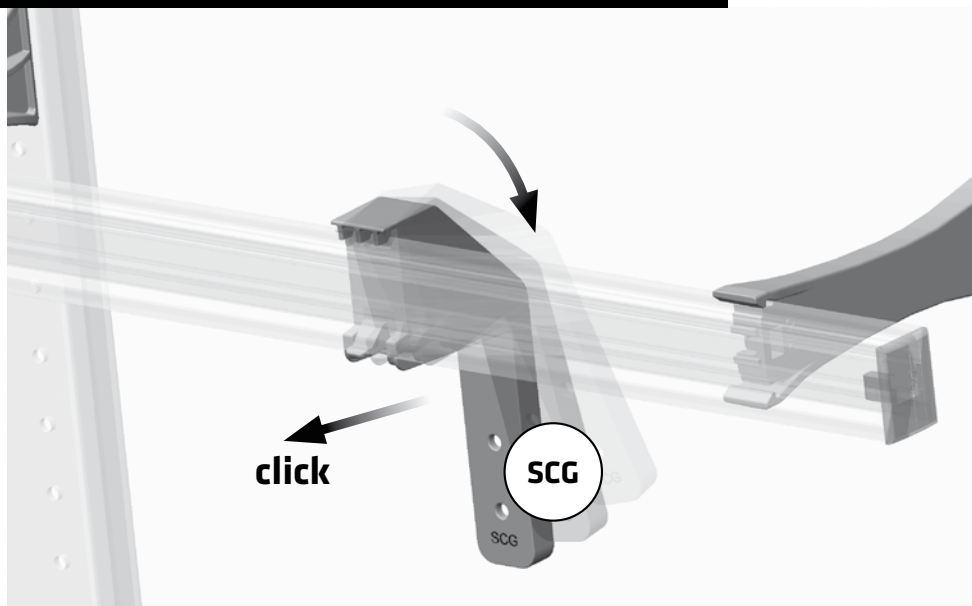

MC

kit per MC-Cub

P* utile = 300 / 400 mm

KIT PER INTERRUTORI MODULARI

AMC7/300 - AMC8/300

AMC7/400 - AMC8/400



KIT PER INTERRUTORI SCATOLATI

ABB / 3VT - 3VA SIEMENS

AMC7/300/S AMC8/300/S

AMC7/400/S AMC8/400/S

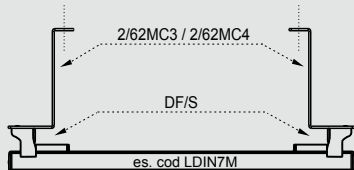

KIT PER INTERRUTORI SCATOLATI SCHNEIDER / SIEMENS / BTICINO

AMC7/300/S - AMC8/300/S

AMC7/400/S - AMC8/400/S

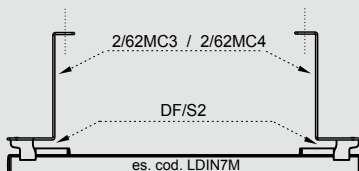

PW

kit per PW-Tech

P* utile = 146 / 196 / 246 /
296 / 346 mm

KIT PER INTERRUTORI MODULARI

APW7/xxx - APW8/xxx - APW10/xxx

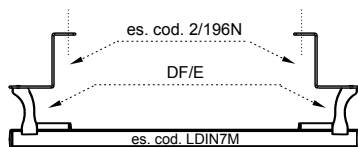

KIT PER INTERRUTORI SCATOLATI

ABB / 3VT - 3VA SIEMENS

APW7/xxx/S - APW8/xxx/S - APW10/xxx/S

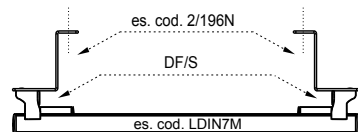

KIT PER INTERRUTORI SCATOLATI SCHNEIDER / SIEMENS / BTICINO

APW7/xxx/S2 APW8/xxx/S2 - APW10/xxx/S2

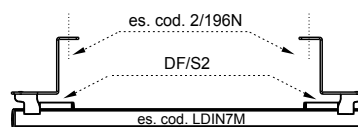

xxx = 146 / 196 / 246 / 296 / 346

W

kit per telaio interno e piastra di cablaggio P* utile = 218 mm

KIT PER INTERRUTORI MODULARI

KW7/2 - KW9/2

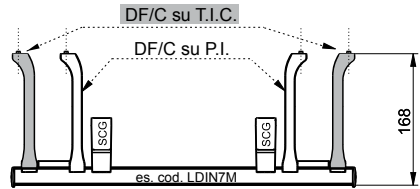

KIT PER INTERRUTORI SCATOLATI

ABB / 3VT - 3VA SIEMENS

W7/125 - W8/125 - W9/125 - W10/125

FISSAGGIO SU P.I.

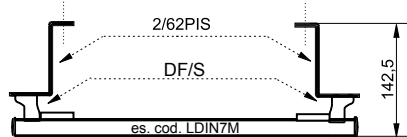

FISSAGGIO SU T.I.C.

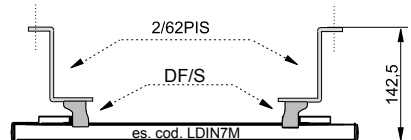

KIT PER INTERRUTORI SCATOLATI

SCHNEIDER / SIEMENS / BTICINO

W7/160 - W8/160 - W9/160 - W10/160

FISSAGGIO SU P.I.

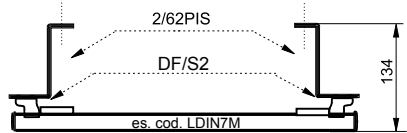

FISSAGGIO SU T.I.C.

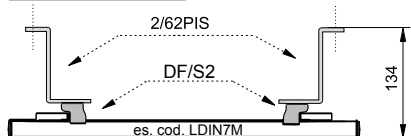

KRP

kit per ripartitori

P* utile = 125 / 218 mm

KIT PER SISTEMA UNIFIX ABB P=125

T7/U - T8/U - T9/U - T10/U

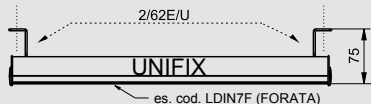

KIT PER SISTEMA UNIFIX ABB P=218

KW7/U - KW8/U - KW9/U - KW10/U

FISSAGGIO SU P.I.

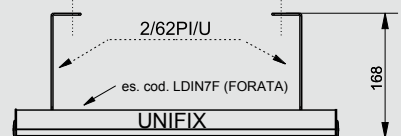

FISSAGGIO SU T.I.C.

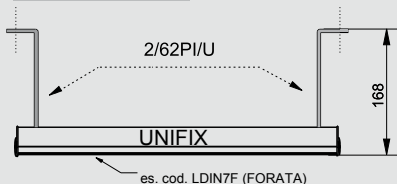

KIT PER SISTEMA TIFAST BTICINO P=125

KT7/T - KT8/T - KT9/T - KT10/T

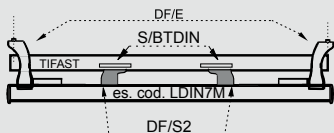

KIT PER SISTEMA TIFAST BTICINO P=218

KW7/T - KW8/T - KW9/T - KW10/T

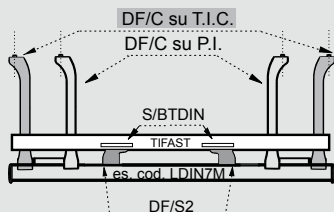

WC

kit per fissaggio
su cornici

DWC7/2 - DWC8/2 - DWC10/3

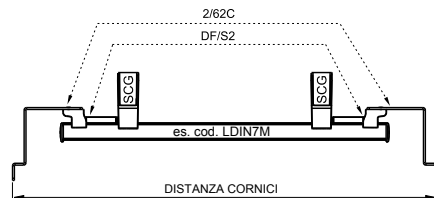

WM

kit per fissaggio
su montanti

AWM7/2 - AWM8/2 - AWM10/3

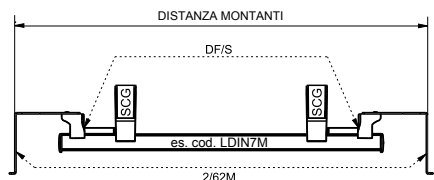

A

kit per morsettiera
orizzontale

DA107/4 - DA108/4 - A109/4

GUIDA OMEGA cod. 600 / 800 / 900 / 1000



*

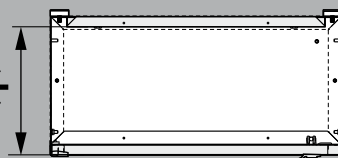

P* utile = distanza tra pannello a cerniera
e piastra o telaio interno di cablaggio.

T.I.C. = telaio interno di cablaggio
P.I. = piastra di cablaggio