

Interruttori automatici magnetotermici

Serie E880+

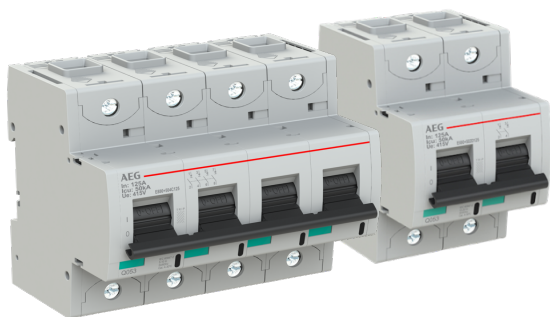

Capacità di rottura

IEC947-2	EN60898
16kA	10kA
50kA	16kA (100-125A); 25kA (80A)

Omologazioni



Caratteristiche tecniche

Serie E880+



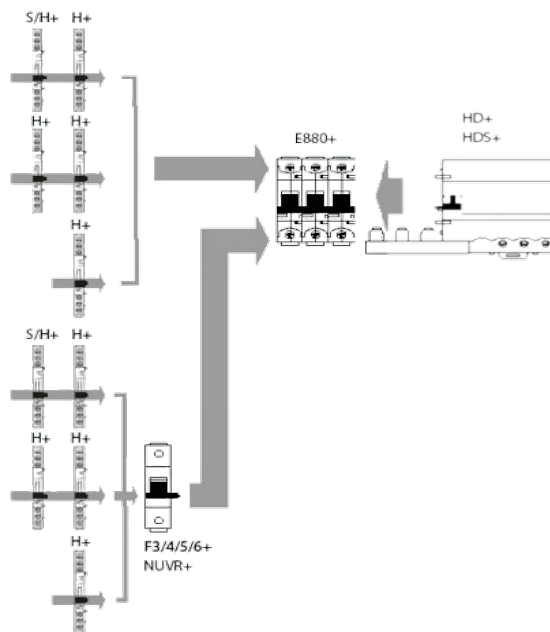



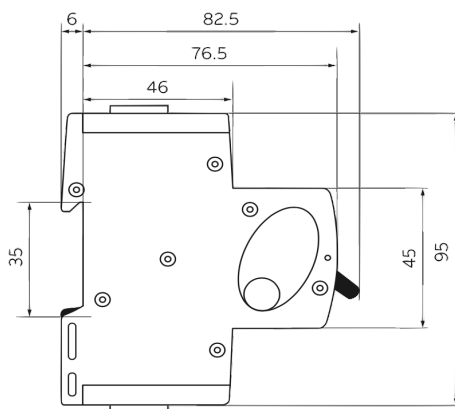
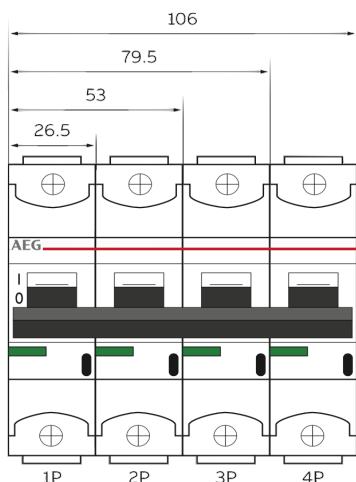

Corrente nominale	80..125A
Numero poli	1, 2, 3, 4
Tensione nominale Un	Versione 16kA 230V/400Vac Versione 50kA 240/415Vac
Tensione massima Umax	AC 230/400V (16kA); AC 240/415 V (50kA)
Tensione minima di esercizio	12V
Frequenza	50/60 Hz
Curva caratteristica	B,C,D
Classe di limitazione	3
Capacità di rottura (secondo EN60947-2)	16kA; 50kA
Temperatura di funzionamento	-25...+60°C
Temperatura di stoccaggio	-40...+70°C
Grado di protezione	IP20 terminali; IP40 involucro
Numero manovre meccaniche	80..100A: 6000/10000; 125A: 4000/8000
Capacità dei terminali	25..50 mm ² cavo flessibile; 25..70 mm ² cavo
Coppia di serraggio	3,5 Nm
Rigidità dielettrica	2,5kV
Resistenza alle vibrazioni	3 g (in direzione x, y, z)
Tropicalizzazione	+55°C/95% U.R. (secondo EN60068-2, Dln40046)
Tensione di isolamento	grado di inquin. 2 500V; grado di inquin. 3 440V
Dimensioni per polo (LxHxP)	25,5x95x82,5 mm
Peso per polo	24,0g per polo





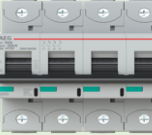

Dimensioni - Serie E880+



Interruttori automatici magnetotermici - Serie E880+

	kA	In (A)	Caratteristica B		Caratteristica C		Caratteristica D	
			Codice	Rif. Interno	Codice	Rif. Interno	Codice	Rif. Interno
 	16	80	E880161B80	664.877	E880161C80	664.817	E880161D80	664.937
		100	E880161B100	664.876	E880161C100	664.816	E880161D100	664.937
		125	E880161B125	664.875	E880161C125	664.815	E880161D125	664.937
	50	80	E880501B80	2CCG0014.24R0001	E880501C80	2CCG0014.27R0001	E880501D80	2CCG0014.30R000
		100	E880501B100	2CCG0014.22R0001	E880501C100	2CCG0014.25R0001	E880501D100	2CCG0014.28R0000
		125	E880501B125	2CCG0014.23R0001	E880501C125	2CCG0014.26R0001	E880501D125	2CCG0014.29R0000
 	16	80	E880162B80	664.874	E880162C80	664.814	E880162D80	664.934
		100	E880162B100	664.873	E880162C100	664.813	E880162D100	664.933
		125	E880162B125	664.872	E880162C125	664.812	E880162D125	664.932
	50	80	E880502B80	2CCG0014.33R0001	E880502C80	2CCG0014.36R0001	E880502D80	2CCG0014.39R0000
		100	E880502B100	2CCG0014.31R0001	E880502C100	2CCG0014.34R0000	E880502D100	2CCG0014.37R0000
		125	E880502B125	2CCG0014.32R0001	E880502C125	2CCG0014.35R0001	E880502D125	2CCG0014.38R0000
 	16	80	E880163B80	664.871	E880163C80	664.811	E880163D80	664.931
		100	E880163B100	664.870	E880163C100	664.810	E880163D100	664.930
		125	E880163B125	664.869	E880163C125	664.809	E880163D125	664.929
	50	80	E880503B80	2CCG0014.4.2R0001	E880503C80	2CCG0014.4.5R0000	E880503D80	2CCG0014.4.8R0000
		100	E880503B100	2CCG0014.4.0R0001	E880503C100	2CCG0014.4.3R0000	E880503D100	2CCG0014.4.6R0000
		125	E880503B125	2CCG0014.4.1R0001	E880503C125	2CCG0014.4.4R0000	E880503D125	2CCG0014.4.7R0000
 	16	80	E880164B80	664.868	E880164C80	664.808	E880164D80	664.928
		100	E880164B100	664.867	E880164C100	664.807	E880164D100	664.927
		125	E880164B125	664.866	E880164C125	664.806	E880164D125	664.926
	50	80	E880504B80	2CCG0014.51R0001	E880504C80	2CCG0014.54R0000	E880504D80	2CCG0014.57R0000
		100	E880504B100	2CCG0014.4.9R0001	E880504C100	2CCG0014.52R0001	E880504D100	2CCG0014.55R0000
		125	E880504B125	2CCG0014.50R0001	E880504C125	2CCG0014.53R0001	E880504D125	2CCG0014.56R0000

Accessori - Serie E880+

	Tipo	Codice	Descrizione		Moduli	Rif. Interno
	Contatti ausiliari	708869	2 contatti ausiliari in commutazione 1CO	E880H+	0,5	2CCG000322R0001
		708870	1 contatto ausiliario 1CO + 1 contatto di scatto 1CO	E880S/H+	0,5	2CCG000323R0001
	Sganciatori a lancio di corrente	708883	24 V AC/DC	F3+	15	2CCG000327R0001
		708873	48...130V AC/DC	F4+	15	2CCG000330R0001
		708872	110...250V AC/DC	F5+	15	2CCG000325R0001
		708871	220...4.00V AC/DC	F6+	15	2CCG000324R0001
	Sganciatore di minima tensione	708876	24...36V AC/DC	NUVR+24	15	2CCG000331R0001
		708875	48...60VAC/DC	NUVR+48	15	2CCG000330R0001
		708874	220...250VAC/DC	NUVR+230	15	2CCG000328R0001
	Dispositivo di blocco	708882	Blocca lucchetto per impedire l'accensione/spegnimen E880+KS Adatto per lucchetti con diametro 4 mm Lucchetto non incluso In caso di blocco su chiuso, l'interruttore può scattare in caso di: - sovraccarico; cortocircuito - sgancio esterno da parte di bobine di minima tensione o a lancio di corrente			2CCG000332R0001